

Diaphragm Valve Type 72 (Manual Type)

Features

- Near-linear flow characteristics.
- Transparent gauge cover (made of polycarbonate) protects the internal and external parts from corrosive chemical solutions and gases.
- The gauge cover also serves as an indicator, allowing easy check of opening degree.



Basic specifications

- Valve Type : Diaphragm Valve Type 72
- Size : 200 mm - 250 mm (8 inch – 10 inch)
- Body Material : U-PVC (Conforming to ASTM D1784 Cell Classification 12454A)
PP (Conforming to ASTM D4101 Cell Classification PP0210B67272)
PVDF (Conforming to ASTM D3222 Cell Classification Type II)
- Seal Material / Diaphragm : EPDM, PTFE, FKM etc.
- Connection / Flanged : JIS B2220 5K, JIS B2220 10K, DIN/EN1092-1 PN10, ANSI B16.5 CLASS150

	FLUID TEMPERATURE °C {°F}	Working Pressure (Normal Temperature) MPa {psi}				Connection Method
		Diaphragm : Rubber		Diaphragm : PTFE		
		200mm	250mm	200mm	250mm	Flanged
U-PVC	0 ~ 60 { 30~140 }	0.2 {30}	0.2 {30}	0.075 {11}	0.075 {11}	○
PP	-20 ~ 90 { -5~195 }	0.2 {30}	0.2 {30}	0.075 {11}	0.075 {11}	○
PVDF	-40 ~ 120 { -40~250 }	0.2 {30}	0.2 {30}	0.075 {11}	0.075 {11}	○

	FLUID TEMPERATURE °C {°F}	Design Pressure (Normal Temperature) MPa {psi}				Connection Method
		Diaphragm : Rubber		Diaphragm : PTFE		
		200mm	250mm	200mm	250mm	Flanged
U-PVC	0 ~ 60 { 30~140 }	0.3 {40}	0.3 {40}	0.1 {15}	0.1 {15}	○
PP	-20 ~ 90 { -5~195 }	0.3 {40}	0.3 {40}	0.1 {15}	0.1 {15}	○
PVDF	-40 ~ 120 { -40~250 }	0.3 {40}	0.3 {40}	0.1 {15}	0.1 {15}	○

Note: The maximum working pressure is the value including the water hammer pressure. Be careful that the maximum working pressure is not exceeded during use.

- * Concerning the allowable pressure for each temperature, material and actuator type, see the technical documents at the next page of this sheet.
- * The diaphragm may become loose due to temperature changes during long storage, operation stop or while in use. Check the conditions and then retighten the bolts and nut between the bonnet and the body to the "bonnet tightening torque". (Failure to do so may cause fluid leakage.)

Certificate / Approval

PED "For details of applicable products, please consult us."

Working pressure vs. Temperature

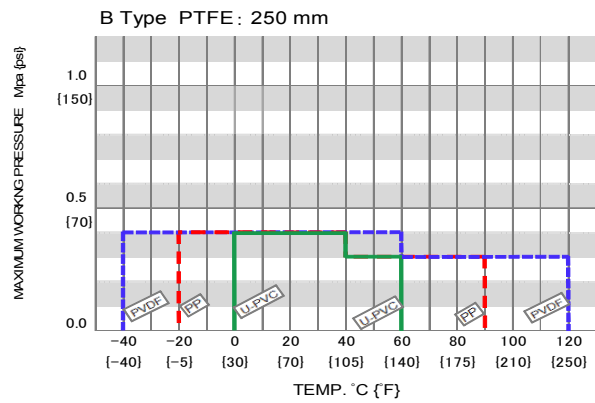
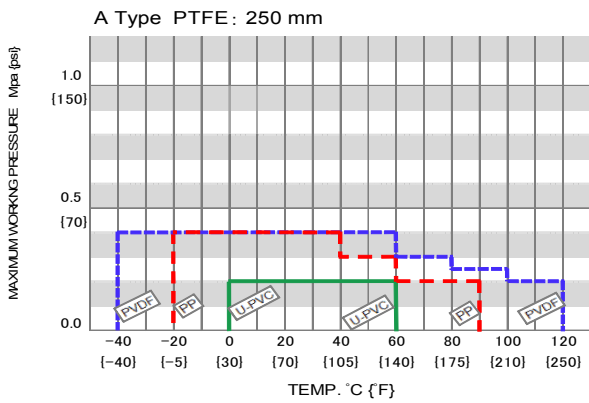
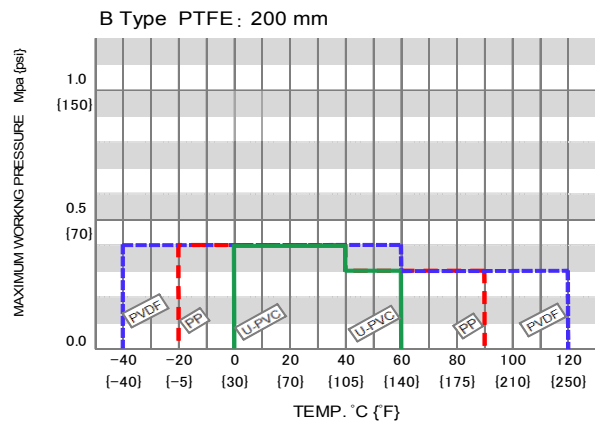
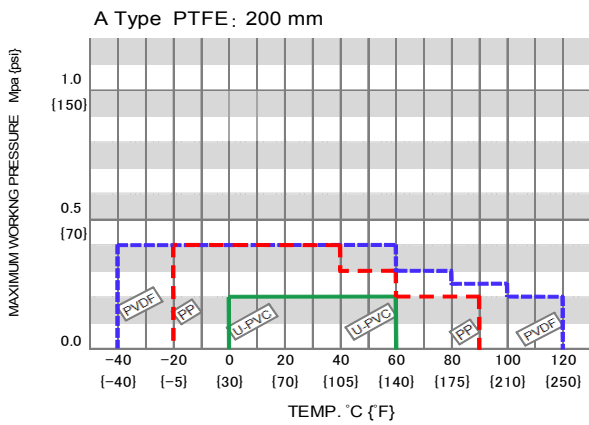
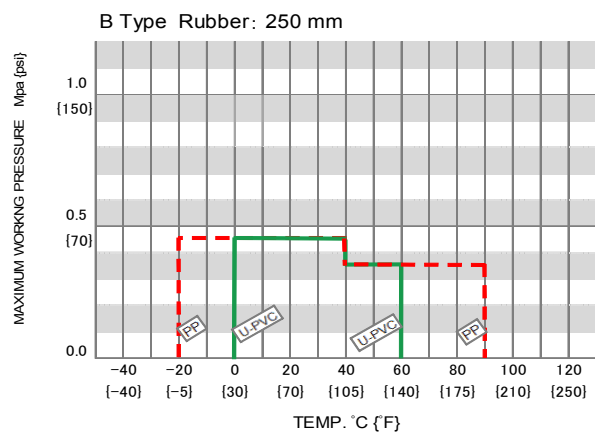
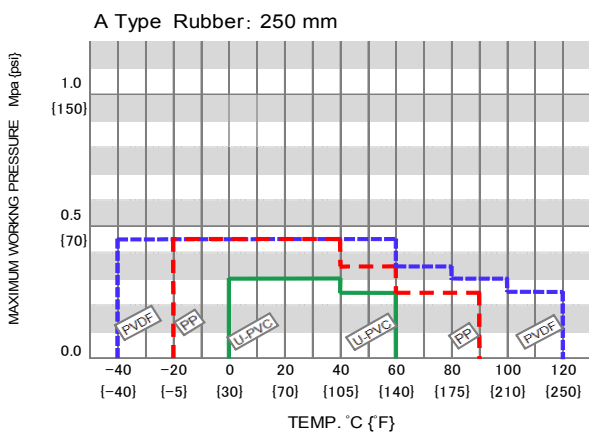
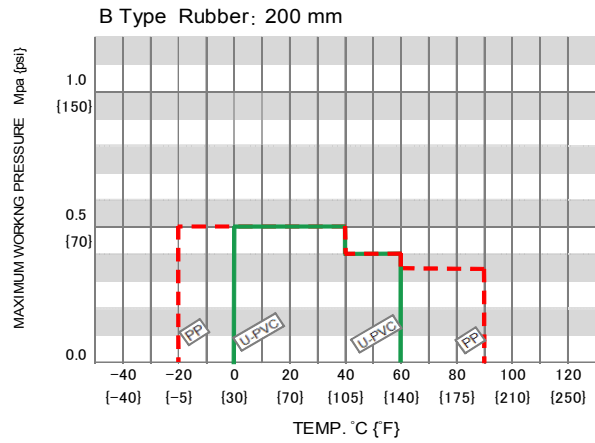
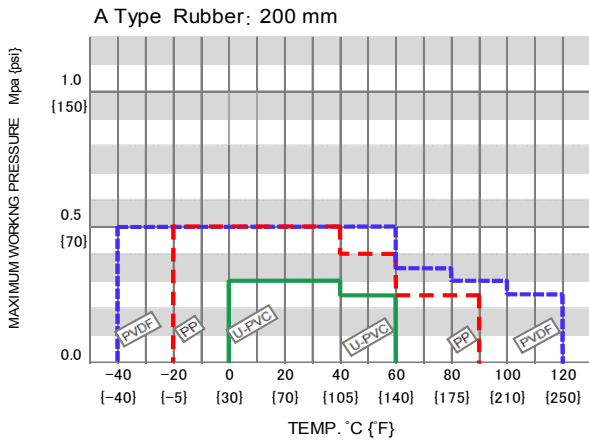

Note : Make sure that the temperature and pressure are within the working range during operation.
 (If the tolerance range is exceeded during use, the valve may be damaged.)

Product dimension

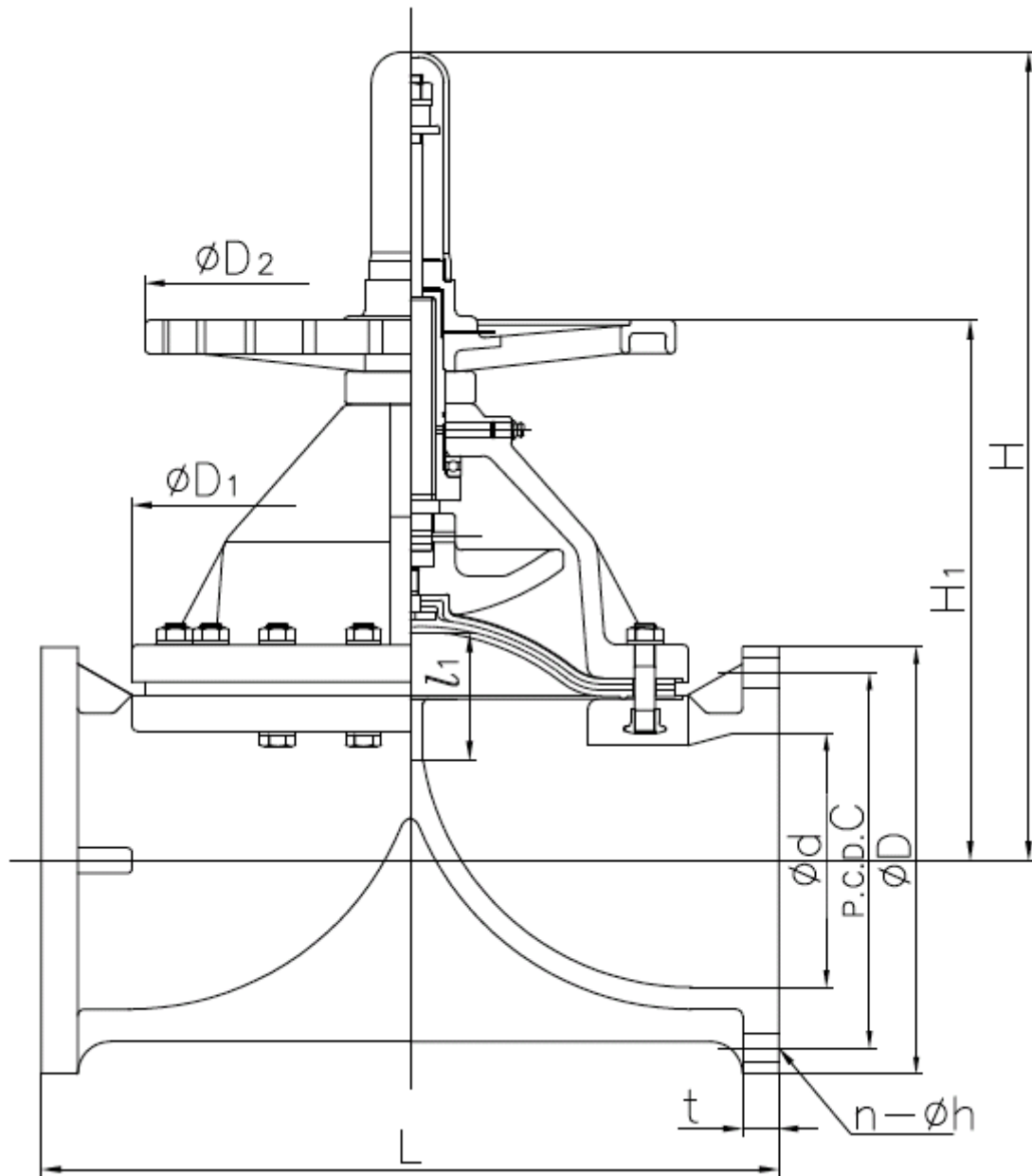

■ JIS, DIN (Unit: mm)

mm	d	D ₁	D ₂	l ₁	H ₁	H	JIS										DIN PN10							
							JIS5K				JIS10K				L	T		D	C	n	h	L	T	
							D	C	n	h	D	C	n	h		U-PVC	PP PVDF						U-PVC	PP PVDF
200	196	430	410	95	419	627	320	280	8	23	330	290	12	23	570	28	32	340	295	8	22	600	30	34
250	247	540	560	128	510	778	385	345	12	23	400	355	12	25	680	30	37	395	350	12	22	730	34	36

■ ANSI (Unit: inch)

inch	mm	d	D ₁	D ₂	l ₁	H ₁	H	ANSI					
								D	C	n	h	L	t
8	200	7.72	16.93	16.14	3.74	16.50	24.69	13.50	11.75	8	0.88	22.44	1.26
10	250	9.72	21.26	22.05	5.04	20.08	30.63	16.00	14.25	12	1.00	26.77	1.46

Parts list

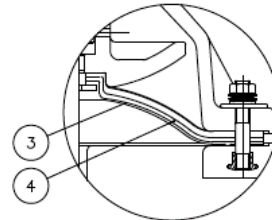
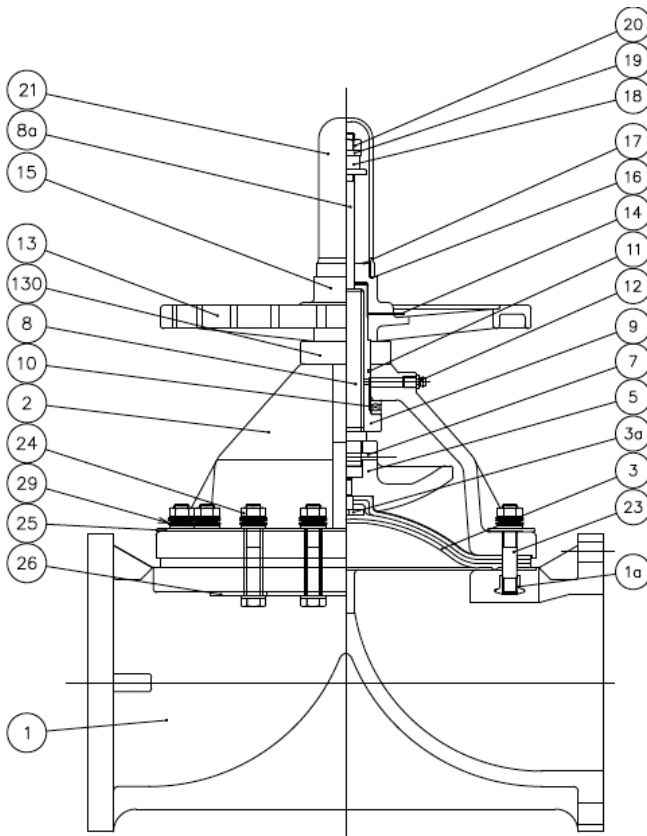

In case of PTFE diaphragm

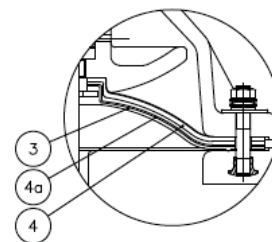

In case of PTFE diaphragm with cushion cover

PART NO./NAME	QTY	MATERIAL	PART NO./NAME	QTY	MATERIAL	PART NO./NAME	QTY	MATERIAL
1 BODY	1	BODY --- BONNET	9 SLEEVE (A)	1	COPPER ALLOY(C3604)	19 SPRING WASHER	1	STAINLESS STEEL(SUS304)
2 BONNET	1	U-PVC --- U-PVC	10 THRUST BEARING (A)	1	SUJ2	20 SET NUT	1	STAINLESS STEEL(SUS304)
		PP --- PP	11 O-RING (A)	1	NBR	21 GAUGE COVER	1	PC
		PVDF --- PPG ⁽¹⁾	12 GREASE NIPPLE	1	COPPER ALLOY(C3604)	23 STUD BOLT/NUT	-	STAINLESS STEEL(SUS304)
		PVDF --- PVDF	13 HAND WHEEL	1	PP	24 BOLT/NUT(A)	-	STAINLESS STEEL(SUS304)
3 DIAPHRAGM	1	EPDM, PTFE, etc.	14 NAMEPLATE	1	U-PVC	25 UPPER BONNET LINER ⁽³⁾	1SET	STAINLESS STEEL(SUS304)
4 CUSHION ⁽²⁾	1	EPDM, etc.	15 CAP	1	PP	26 BODY LINER ⁽³⁾	1SET	STAINLESS STEEL(SUS304)
5 COMPRESSOR	1	STAINLESS STEEL(FC200) (Unichrome plating)	16 STOPPER	1	EPDM	29 CONICAL SPRING WASHER ⁽⁴⁾	-	STAINLESS STEEL(SUS304)
7 COMPRESSOR PIN	1	STAINLESS STEEL(SUS304)	17 VALVE SEAT	1	STAINLESS STEEL(SUS304)	1a INSERTED NUT	-	STAINLESS STEEL(SUS304)
8 STEM	1	COPPER ALLOY	18 STOPPER	1	Chromized STEEL(SS400) (Unichrome plating)	3a INSERTED METAL OF DIAPHRAGM (A)	1	STAINLESS STEEL(SUS304), TITANIUM (with palladium)
8a INDICATOR ROD	1	STAINLESS STEEL(SUS304)						

Note:

- (1) Bonnet PPG 15 - 100 mm: black. 125 - 250 mm: ivory. (2) Is used when the diaphragm material is PTFE.
- (3) Is used when the body material is PP or PVDF. (4) Is used when the body material is PVDF.

Cv value for each opening degree

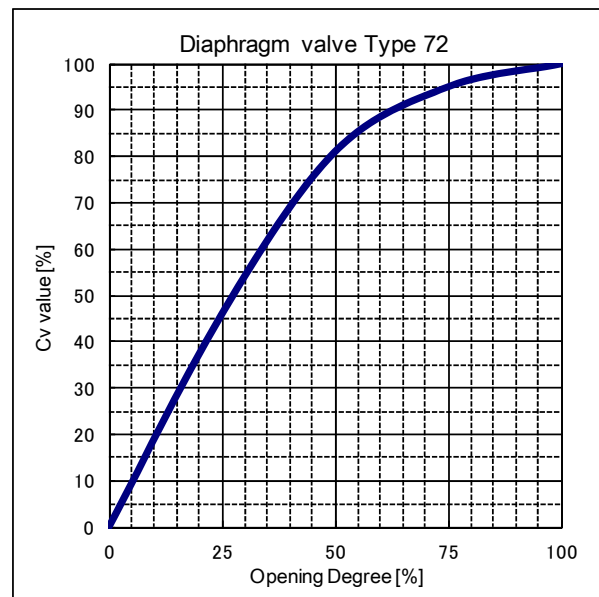

FULL-OPEN Cv VALUE

mm	200	250
inch	8	10
FULL-OPEN Cv VALUE	700	1000

Handle rotation [Full open (rotation/lift) Full close]

SIZE		ROTATION
mm	inch	
200	8	19.0
250	10	25.0

Operating torque at maximum working pressure

Operating torque(O→S) Unit:N-m { ib-inch }

mm	inch	Rubber Diaphragm		PTFE Diaphragm	
		N-m	{ ib-inch }	N-m	{ ib-inch }
200	8	55	{ 487 }	130	{ 1151 }
250	10	130	{ 1151 }	230	{ 2036 }

Bonnet tightening torque

Bonnet tightening torque(O→S) Unit:N-m { ib-inch }

mm	inch	Rubber Diaphragm		PTFE Diaphragm	
		N-m	{ ib-inch }	N-m	{ ib-inch }
200	8	30	{ 266 }	30	{ 266 }
250	10	30	{ 266 }	30	{ 266 }

Options

In addition to the standard product, the following options are also available according to your requirements.

① PVDF Cushion Cover Model

For corrosive fluid transport lines, we offer PVDF cushion cover accessories having excellent gas barrier performance to prevent deterioration due to permeation of gas from the diaphragm.

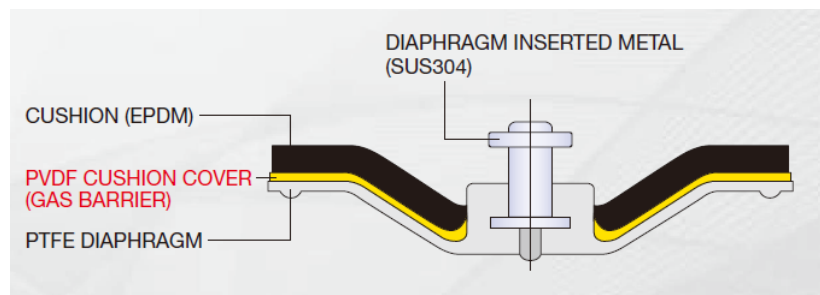

② Electrolytic Model

For chlorine gas lines in electrolysis plants, we offer electrolytic options using highly corrosion resistant special metal to prevent corrosion of inserted diaphragm fittings.

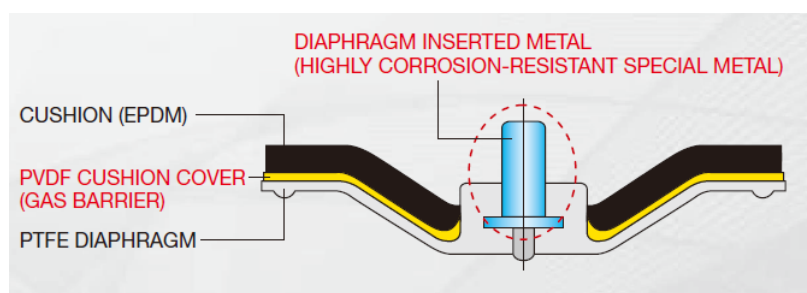

Product weight

Unit : kg

mm	inch	Body material			
		U-PVC	PP	PVDF	PVDF
		Bonnet material			
		U-PVC	PP	PPG	PVDF
200	8	52.6	45.0	57.3	62.3
250	10	93.3	77.3	97.6	110.2

Product model code list

ACTUATION	TYPE	OPERATING SYSTEM	BODY MATERIAL	SEAL MATERIAL	CONNECTION	STANDARD	SIZE
V	72	MH	*	*	*	*	***
V	72	MH	U	E	F	1	200
MANUAL VALVE	TYPE 72	ROUND HANDLE	U-PVC	EPDM	FLANGED	JIS10K	200mm
			P	T		5	.
			F	PTFE		D	250
			G			A	250mm

Installation, Operation and Maintenance Manual

For details of Installation, Operation and Maintenance, please refer IOM at below link.

http://www.asahi-yukizai.co.jp/en/product/mt_pdf/a_manual_valve_1_03.pdf