

Diaphragm Valve Type AN (Automatic Type)

Features

- Near-Linear flow characteristics
- A new type of rubber having a high reliability in leakage prevention is used for the diaphragm and cushion.
- The original design achieves high sealing performance with low torque.
- Bayonet structure allowing quick diaphragm replacement
- Equipped with a bottom stand allowing easy and secure replacement.



Basic specifications

- Valve Type : Diaphragm Valve Type AN
- Size : 15 mm - 50 mm (1/2 inch – 2 inch)
- Body Material : U-PVC (Conforming to ASTM D1784 Cell Classification 12454A)
C-PVC (Conforming to ASTM D1784 Cell Classification 23567-A)
PP (Conforming to ASTM D4101 Cell Classification PP0210B67272)
PVDF (Conforming to ASTM D3222 Cell Classification Type II)
- Seal Material / Diaphragm : EPDM, PTFE, FKM etc.
- Connection / Flanged : JIS B2220 10K, DIN/EN1092-1 PN10, ANSI B16.5 CLASS150

Body Material	Fluid Temperature °C { °F }	Max. working pressure (Normal temperature) MPa { psi }	Connection method
			Flanged
U-PVC	0 ~ 60 { 30~140 }	1.0 { 150 }	○
C-PVC	0 ~ 90 { 30~195 }	1.0 { 150 }	○
PP	-20 ~ 90 { -5~195 }	1.0 { 150 }	○
PVDF	-40 ~ 120 { -40~250 }	1.0 { 150 }	○

Note: The maximum working pressure is the value including the water hammer pressure. Be careful that the maximum working pressure is not exceeded during use.

- * Concerning the allowable pressure for each temperature, material and actuator type, see the technical documents at the next page of this sheet.
- * The diaphragm may become loose due to temperature changes during long storage, operation stop or while in use. Check the conditions and then retighten the bolts and nut between the bonnet and the body to the "bonnet tightening torque". (Failure to do so may cause fluid leakage.)

Certificate / Approval

PED "For details of applicable products, please consult us."

Working pressure vs. Temperature

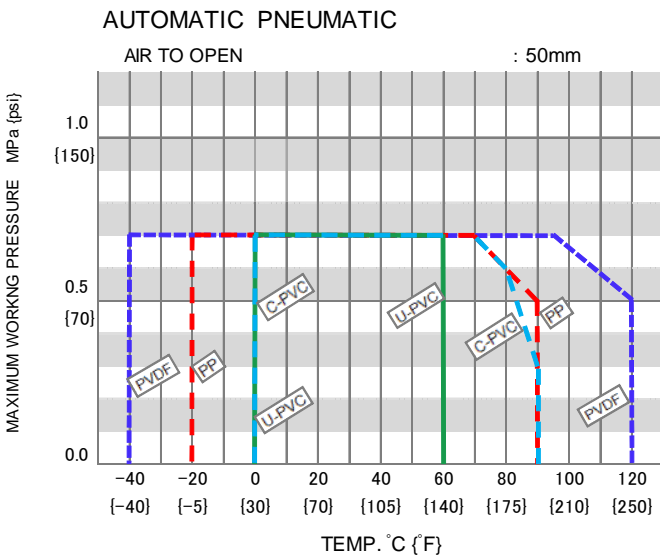
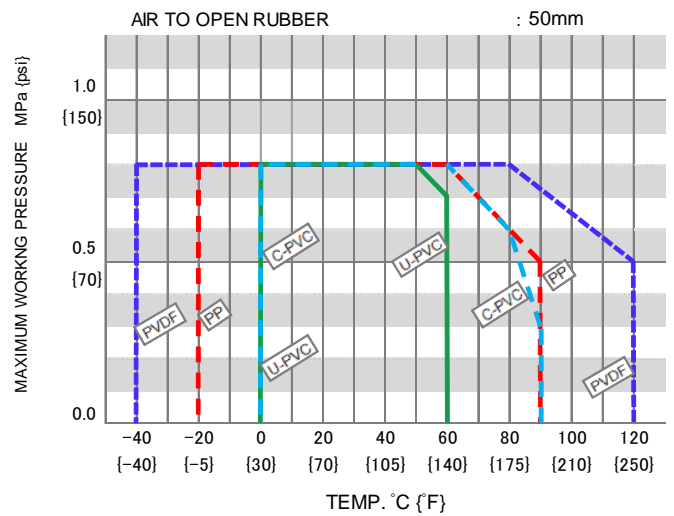
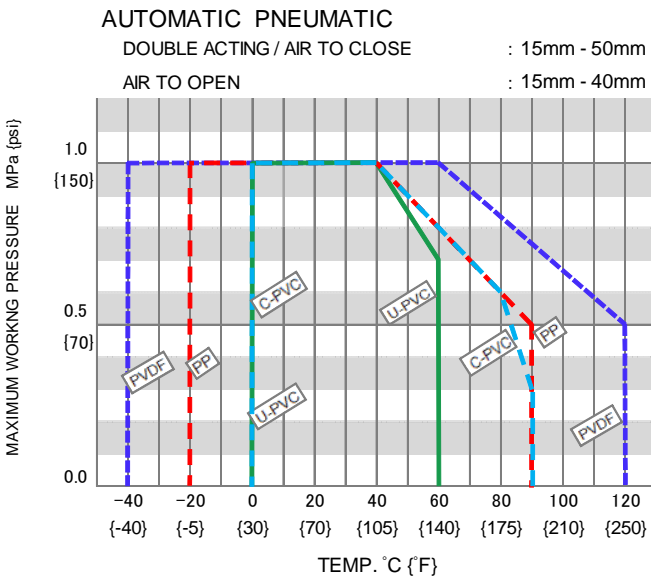

Note : Make sure that the temperature and pressure are within the working range during operation.
 (If the tolerance range is exceeded during use, the valve may be damaged.)

Product dimension

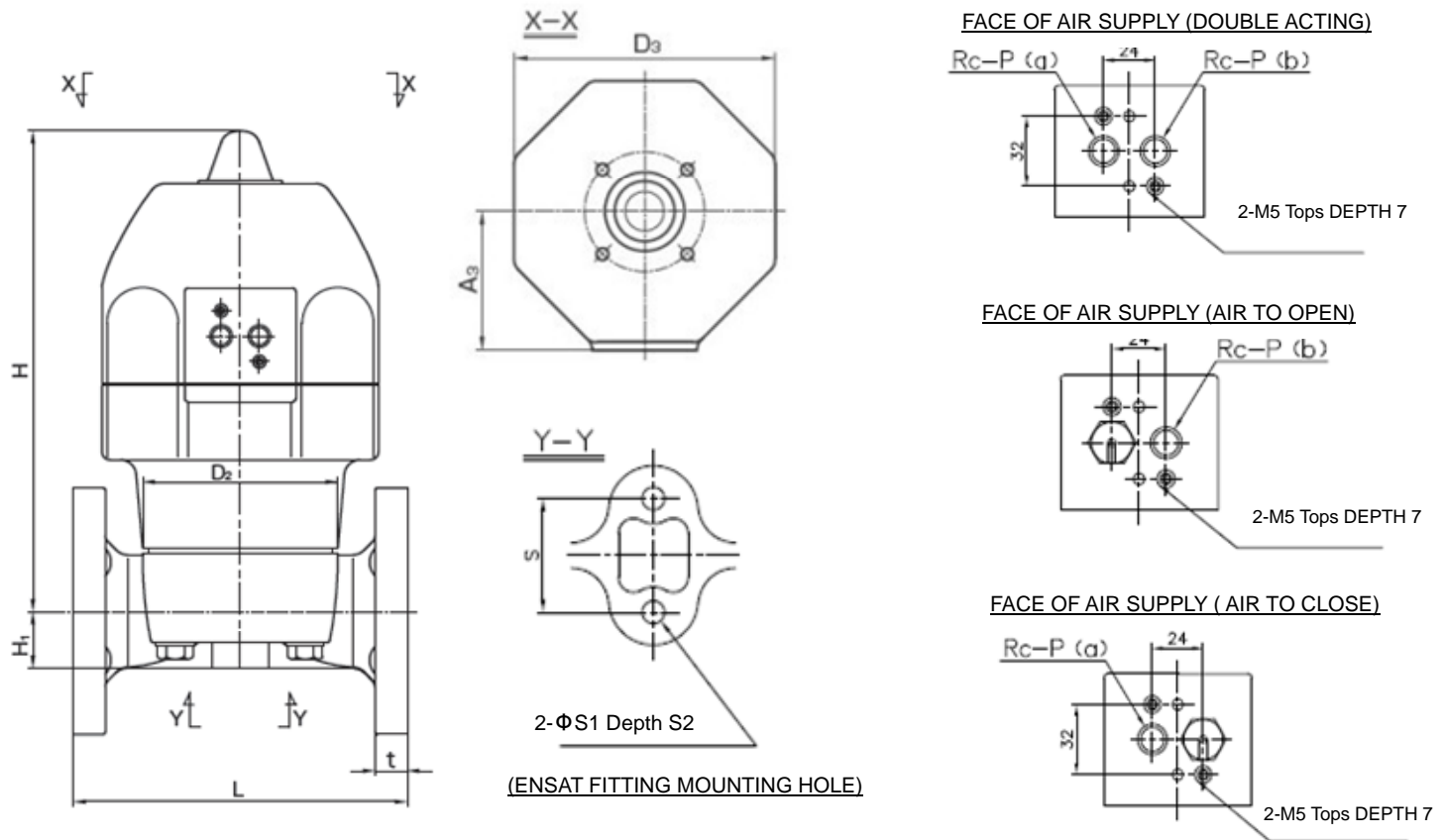

■ JIS, DIN (Unit: mm)

mm	D ₂	D ₃	H	H ₁	A ₃	S	S ₁	S ₂	P	JIS10K		DIN PN10	
										L	t	L	t
15	54X66	130	186	19.5	68	25	7	13	1/4	110	12	130	12
20	54X66	130	188	17.5	68	25	7	13	1/4	120	13	150	13
25	67X80	130	193	18.5	68	25	7	13	1/4	130	13	160	13
32	67X80	130	197	22.5	68	25	7	13	1/4	142	16	180	16
40	108X108	174	293	27.5	92	45	9	15	1/4	180	16	200	20
50	123X123	174	302	36	92	45	9	15	1/4	210	20	230	22

■ ANSI (Unit: inch)

inch	mm	D ₂	D ₃	H	H ₁	A ₃	S	S ₁	S ₂	P	ANSI CLASS150		
											L		t
											GRINNELL STANDARD	AV STANDARD	
1/2	15	2.13X2.60	5.12	7.32	0.77	2.68	0.98	0.28	0.51	1/4	4.25	4.33	0.43
3/4	20	2.13X2.60	5.12	7.40	0.69	2.68	0.98	0.28	0.51	1/4	5.88	4.72	0.51
1	25	2.64X3.15	5.12	7.60	0.73	2.68	0.98	0.28	0.51	1/4	5.88	5.12	0.59
1 1/4	32	2.64X3.15	5.12	7.76	0.89	2.68	0.98	0.28	0.51	1/4	6.38	-	0.63
1 1/2	40	4.25X4.25	6.85	11.54	1.08	3.62	1.77	0.35	0.59	1/4	6.94	7.09	0.63
2	50	4.84X4.84	6.85	11.89	1.42	3.62	1.77	0.35	0.59	1/4	7.94	8.27	0.79

ACTUATOR SELECTION CHART

SIZE	ACTUATOR TYPE		
	DOUBLE ACTING	AIR TO OPEN	AIR TO CLOSE
15mm(1/2inch)	AN-1DA	AN-1AO	AN-1AS
20mm(3/4inch)			
25mm(1inch)	AN-2DA	AN-2AO	AN-2AS
32mm(1 1/4inch)			
40mm(1 1/2inch)	AN-3DA	AN-3AO	AN-3AS
50mm(2inch)	AN-4DA	AN-4AO	AN-4AS

Parts list

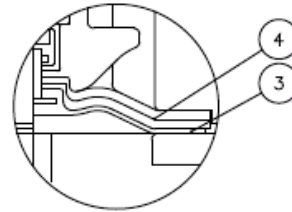
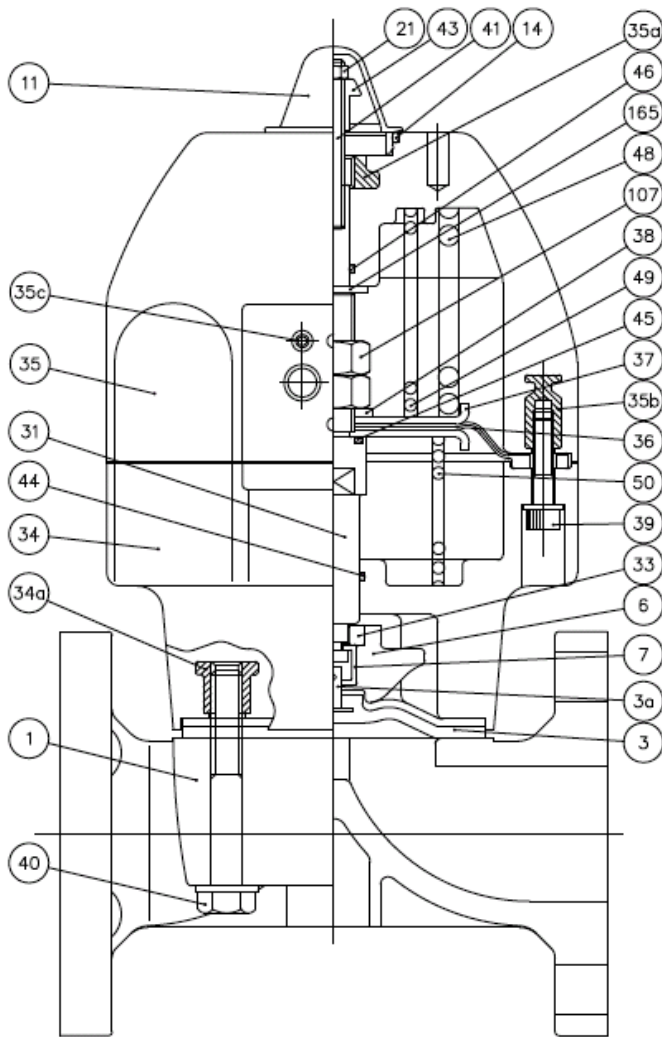

In case material of Diaphragm is PTFE

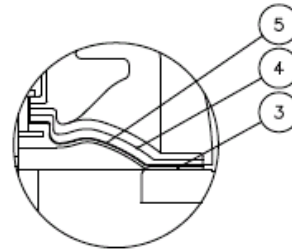

In case material of diaphragm is PTFE with cushion cover.

Face of Air Supply (Air to Open)

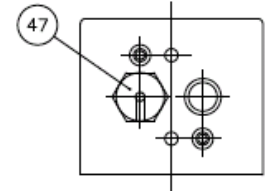

Face of Air Supply (Air to Shut)

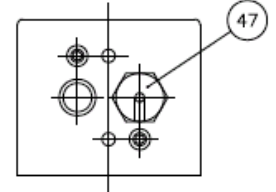

PART NO./NAME	QTY	MATERIAL	PART NO./NAME	QTY	MATERIAL	PART NO./NAME	QTY	MATERIAL
1 BODY	1	PVC, C-PVC, PP, PVDF	34 CYLINDER BODY	1	PPG	44 O-RING (D)	1	NBR
3 DIAPHRAGM	1	EPDM, PTFE, OTHERS	34a INSERTED METAL OF CYLINDER BODY	1	COPPER ALLOY	45 O-RING (E)	1	NBR
3a INSERTED METAL OF DIAPHRAGM	1	STAINLESS STEEL	35 CYLINDER BONNET	1	PPG	46 O-RING (F)	1	NBR
4 CUSHION	1	EPDM User for PTFE Diaphragm	35a INSERTED METAL OF CYLINDER BONNET (A)	1	STAINLESS STEEL	47 NIPPLE	1	COPPER ALLOY User for Air to Shut and Air to open
5 CUSHION COVER	1	Nothing, PVDF User for PTFE Diaphragm	35b INSERTED METAL OF CYLINDER BONNET (B)	8	COPPER ALLOY	48 SPRING (A)	1	STAINLESS STEEL(SWOSM-B) User for Air to open
6 COMPRESSOR	1	PVDF	35c SCREWED METAL OF CYLINDER BONNET	2	STAINLESS STEEL	49 SPRING (B)	1	STAINLESS STEEL(SWOSM-B) User for Air to open
7 JOINT	1	STAINLESS STEEL	36 CYLINDER DIAPHRAGM	1	NBR	50 SPRING (C)	1	STAINLESS STEEL(SWOSM-B) User for Air to Shut
11 GAUGE COVER	1	PC	37 CYLINDER DIAPHRAGM PLATE	2	STAINLESS STEEL	107 LOCK NUT	2	STAINLESS STEEL
14 O-RING (A)	1	EPDM	38 CONICAL SPRING WASHER (B)	1	STAINLESS STEEL	165 WASHER (A)	1	STAINLESS STEEL
21 NUT	1	STAINLESS STEEL	39 BOLT (A)	8	STAINLESS STEEL			
31 STEM (A)	1	COPPER ALLOY	40 BOLT (B)	4	STAINLESS STEEL			
33 COMPRESSOR PUSHING PLATE	1	COPPER ALLOY	41 INDICATING ROD	1	STAINLESS STEEL			
			43 STOPPER	1	STAINLESS STEEL			

Diaphragms except EPDM and PTFE are available in FKM, VIFLON®C (FKM-C), VIFLON®F (FKM-F), CPE, CSM, NBR and IIR when required. The shape and appearance of assembly differ a little with nominal size compared to this drawing.

Compatible Actuator

- Lightweight and compact size due to plastic actuator.
- Air piping is compatible with NAMUR standard.
- Options are easily removable/ replaceable and can be mounted later (except positioner) .
- Equipped with stopper that can be adjusted at full closed position..



BASIC SPECIFICATIONS

DOUBLE ACTING	ACTUATOR TYPE				UNIT
	AN-1DA	AN-2DA	AN-3DA	AN-4DA	
OPERATING PRESSURE	0.4-0.6				MPa
AIR CONSUMPTION	2.6	2.7	9.6	9.8	NI/OPEN & CLOSE (0.4MPa)
AIR SUPPLY BORE	Rc1/4				

AIR TO OPEN	ACTUATOR TYPE				UNIT
	AN-1AO	AN-2AO	AN-3AO	AN-4AO	
OPERATING PRESSURE	0.4-0.6				MPa
AIR CONSUMPTION	0.8		3.4		NI/OPEN & CLOSE (0.4MPa)
AIR SUPPLY BORE	Rc1/4				

AIR TO CLOSE	ACTUATOR TYPE				UNIT
	AN-1AS	AN-2AS	AN-3AS	AN-4AS	
OPERATING PRESSURE	0.4-0.6				MPa
AIR CONSUMPTION	1.8	1.9	6.1	6.3	NI/OPEN & CLOSE (0.4MPa)
AIR SUPPLY BORE	Rc1/4				

OPTION COMBINATION

COMBINATION NO.	1 ^{*4}	2 ^{*4}	3	4 ^{*4}	5	6	7	8	9
SOLENOID VALVE ^{*1}	○	—	—	○	○	—	○	—	—
FILTER REGULATOR	—	—	—	○	—	—	○	—	○
SPEED CONTROLLER ^{*2}	◎	○	—	◎	◎	○	◎	—	—
LIMIT SWITCH ^{*3}	—	—	○	—	○	○	○	—	—
POSITIONER (E/P,P/P)	—	—	—	—	—	—	—	○	○

*1 Equipped with a built-in speed controller and bypass valve.

*2 ◎ indicates solenoid valve-dedicated type.

*3 When using the limit switch at 1 to 100 mA or 5 to 30V, contact our sales office in your area.

*4 The "full opening adjustment" and "manual override (air to open only)" are available only for the combination No. 1, 2 and 4.

DATASHEET

OPTION LIST	MANUFACTURER	BASIC SPECIFICATIONS
SOLENOID VALVE NAMUR	KONAN	<ul style="list-style-type: none"> WATER PROOF, EXPLOSION PROOF POWER SOURCE AC100V, AC110V, AC200V, AC220V, DC24V
FILTER REGULATOR	KONAN	
SPEED CONTROLLER	KONAN	* Since a solenoid valve has a built-in exhaust valve, when a solenoid valve is mounted, no speed controller is necessary.
BYPASS VALVE (SPEED CONTROLLER)	KONAN	
LIMIT SWITCH	AZBIL (formerly YAMATAKE)	<ul style="list-style-type: none"> WATER PROOF, EXPLOSION PROOF OPEN: 1pc, CLOSE: 1pc, OPEN/CLOSE: 2pcs
POSITIONER	YTC	<ul style="list-style-type: none"> E/P: INPUT SIGNAL CURRENT DC 4-20 mA P/P: INPUT SIGNAL AIR PRESSURE 0.02 - 0.1 MPa
MANUAL OVERRIDE	ASAHI YUKIZAI	
FULL OPENING ADJUSTMENT	ASAHI YUKIZAI	

Cv value for each opening degree

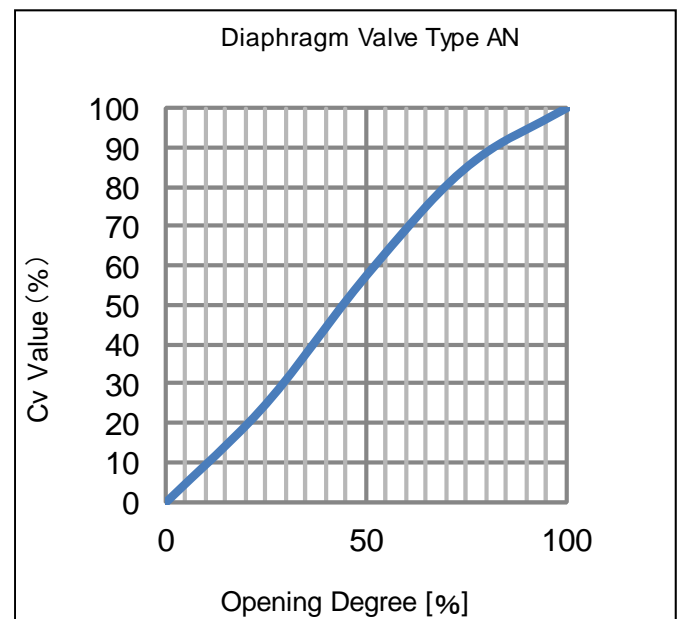

FULL-OPEN Cv VALUE

mm	15	20	25	32	40	50
inch	1/2	3/4	1	1 1/4	1 1/2	2
FULL-OPEN Cv VALUE	4.8	5.3	8.5	11	26	43

Product weight

TYPE 14 [AUTOMATIC PNEUMATIC TYPE AN]

Unit : kg

mm	inch	DOUBLE ACTING				AIR TO OPEN				AIR TO CLOSE			
		U-PVC	C-PVC	PP	PVDF	U-PVC	C-PVC	PP	PVDF	U-PVC	C-PVC	PP	PVDF
15	1/2	2.5	2.5	2.0	2.5	3.0	3.0	2.5	3.0	2.6	2.6	2.1	2.6
20	3/4	2.5	2.5	2.0	2.5	3.0	3.0	2.5	3.0	2.6	2.6	2.1	2.6
25	1	2.5	2.5	2.5	3.0	3.0	3.0	3.0	3.5	2.6	2.6	2.6	3.1
32	1 1/4	3.0	3.0	2.5	3.0	3.5	3.5	3.0	3.5	3.1	3.1	2.6	3.1
40	1 1/2	5.5	5.5	5.0	5.5	7.0	7.0	6.5	7.0	5.7	5.7	5.2	5.7
50	2	6.5	6.5	5.5	6.5	8.0	8.0	7.0	8.0	6.7	6.7	5.7	6.7

Product model code list

ACTUATION	TYPE	ACTUATOR TYPE	ACTION /POWER SOURCE	BODY MATERIAL	SEAL MATERIAL	CONNECTION	STANDARD	SIZE
A	14	*	*	*	*	F	*	***
A AUTOMATIC VALVE	14 TYPE 14	PNEUMATIC	PNEUMATIC	U U-PVC	E EPDM	F FLANGED	1 JIS10K	015 15mm
		N TYPE AN	F DOUBLE ACTING	C C-PVC	T PTFE		D DIN	?
		V TYPE AV	G AIR TO OPEN	P PP			A ANSI	050 50mm
			S AIR TO CLOSE	F PVDF				

Installation, Operation and Maintenance Manual

For details of Installation, Operation and Maintenance, please refer IOM at below link.

http://www.asahi-yukizai.co.jp/en/product/mt_pdf/a_automatic_valve_1_01.pdf